

Quartz 6mm Slider Assembly 2PHLF

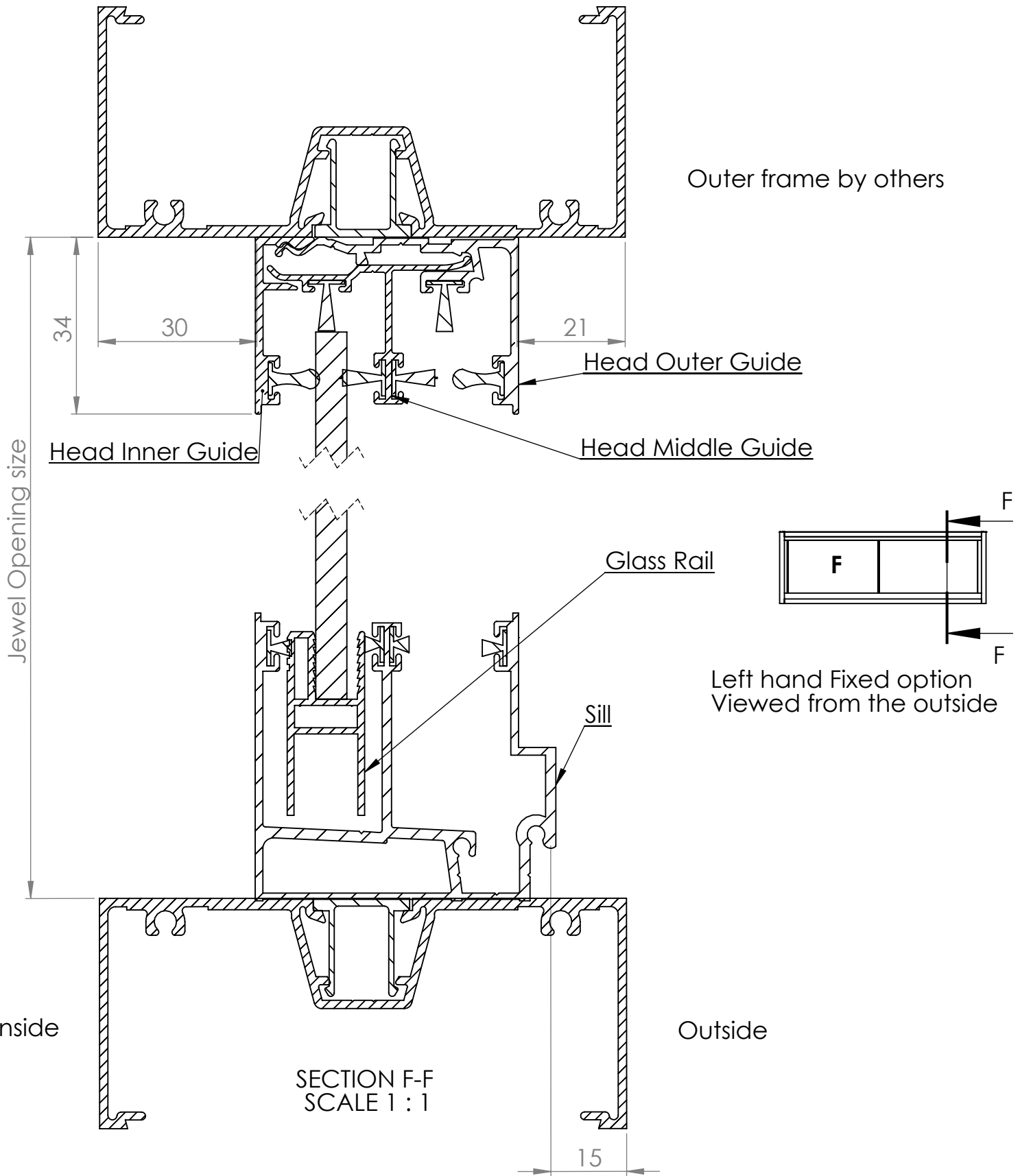

DATE	27/8/20	REVISION	3		A4
DWG NO.	For technical assistance contact (03) 97708708			SHEET 1 OF 2	SCALE:1:10

Quartz 6mm Slider Assembly 2PHLF

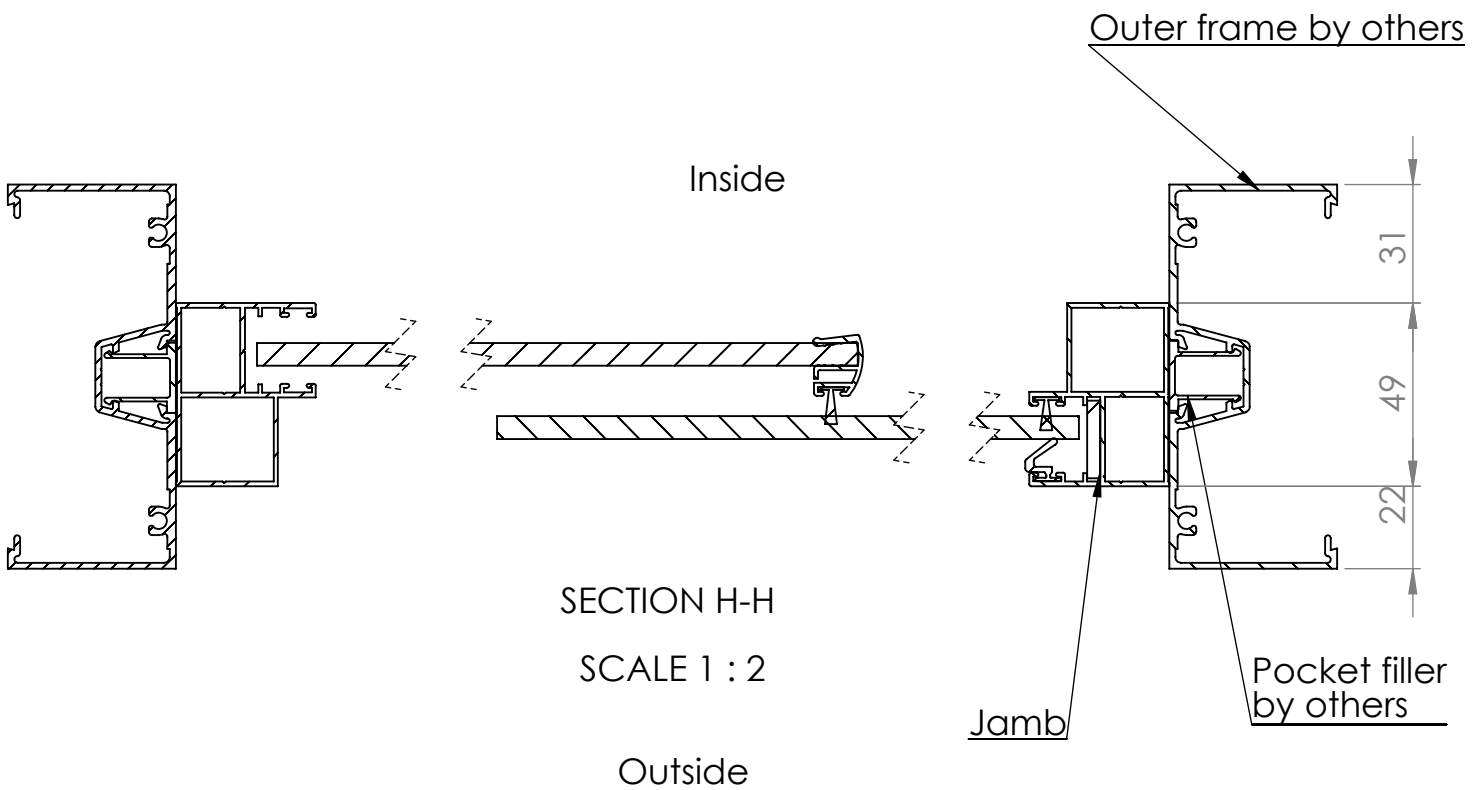
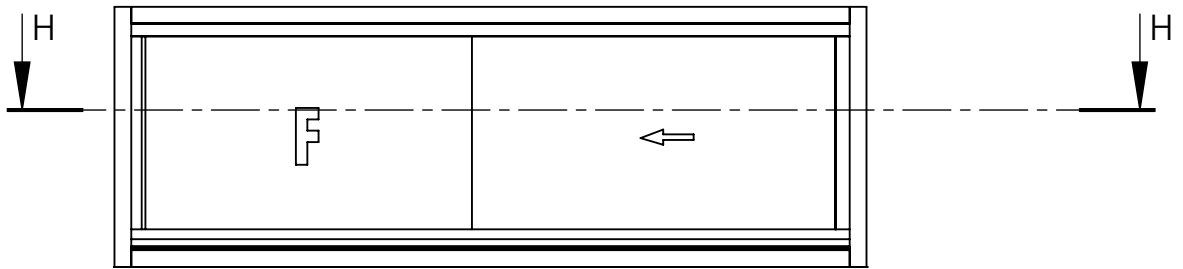

DATE	27/8/20	REVISION	3		A4
DWG NO.	For technical assistance contact (03) 97708708			SHEET 2 OF 2	SCALE:1:10