

Pegasus

50.21



macchine edili ed agricole
S.r.l.
d DIECI

Pegasus 50.21

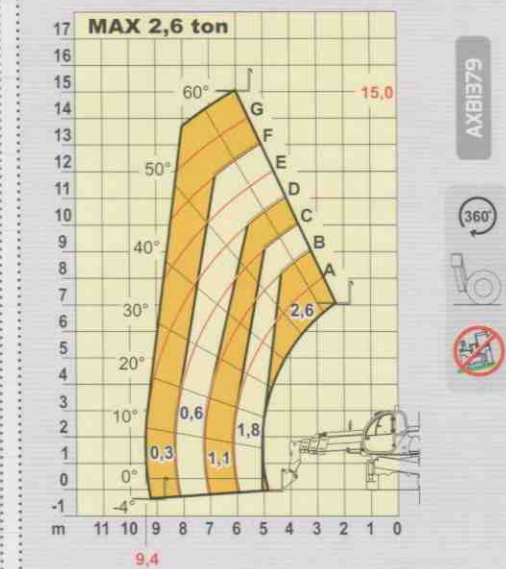
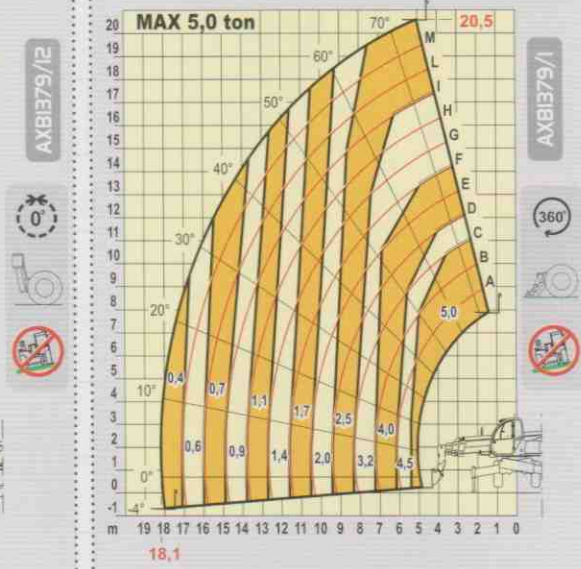
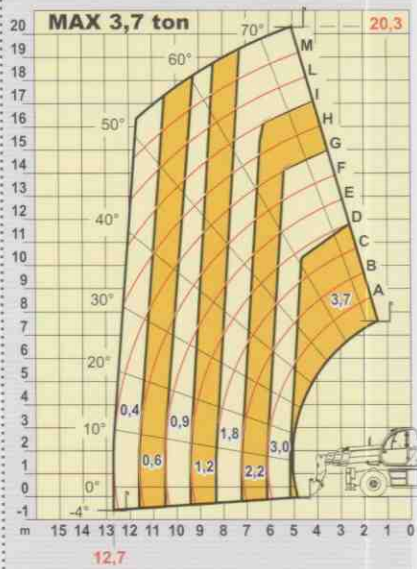

PERFORMANCES

Maximum capacity:	5.000 kg
Capacity at maximum height on stabilizers:	2.500 kg
Capacity at maximum height on tyres:	1.800 kg
Capacity at maximum boom extension on stabilizers:	400 kg
Capacity at maximum boom extension on tyres:	400 kg
Maximum lifting height on stabilizers:	20,50 m
Maximum lifting height on tyres:	20,30 m
Maximum horizontal boom extension:	18,10 m
Boom extension at maximum height:	2,50 m
Fork tilting angle:	134°
Tearing force:	5.700 daN
Towing force:	9.400 daN
Maximum allowable slope:	40 %
Total empty weight:	16.900 kg
Max speed:	40 km/h



ENGINE

DEUTZ BF4M2012C - TA - 103 kW ENGINE	
Maximum power:	103 kW (141 cv) a 2500 rpm
Operating principle:	four-stroke, diesel engine
Cylinder number and layout:	4, vertical in line
Displacement:	4038 cm ³ -Turbo compressor aftercooler
Cooling system:	liquid



REFUELLING (litre)

Hydraulic tank:	255
Fuel tank:	126



STANDARD DEVICES

- Hydraulic movements with Danfoss proportional control valve.
- Anti-tipping device with block for hazardous movements.
- Continuous turret rotation over 360°.
- Oscillation block on rear axle.
- Hydraulic socket for possible accessories on boom head.
- Closed soundproof FOPS approved driver's cab, with heating.
- Stabilizers.



TYRES

Tyres:	18 - R22,5"
--------	-------------



OPTIONAL AND ACCESSORIES

Optional and Accessories: see the relevant catalogue



TRANSMISSION

Transmission: Hydrostatic with variable delivery pump
 Hydraulic engine: with automatic adjustment
 Reversing gear: Electro - hydraulic
 Inching pedal for controlled forward movement
 Servocontrolled 2 speed gearbox



HYDRAULIC SYSTEM

Gear pump with capacity at max speed: 135 lt/1'
 Max working pressure: 230 bar
 Control valve with joystick: 5 in 1 proportional



DIFFERENTIAL AXLES

Steering axes: 2, with planetary reduction gears
 Type of steering: 4 wheels / transversal / 2 wheels
 Front axle: levelling
 Rear axle: oscillating (can be blocked)
 Service brake: oil bath on the 4 wheels with double hydraulic system and servo brake

Negative parking brake.

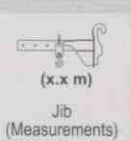
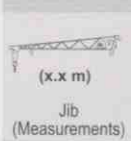
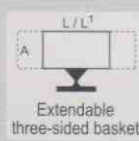

SYMBOLS KEY

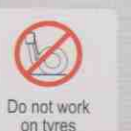
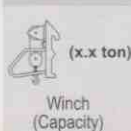

Equipments

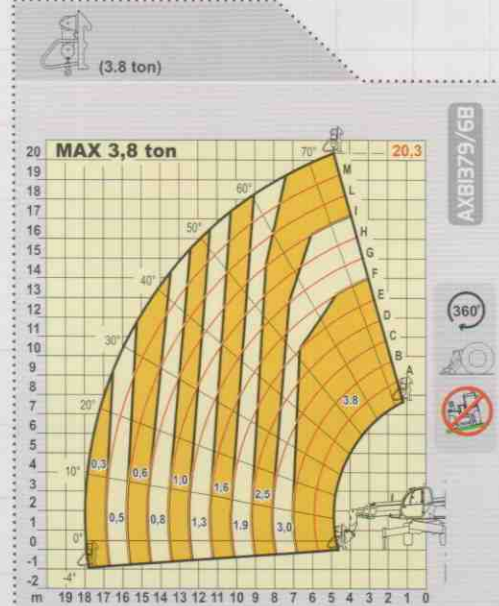
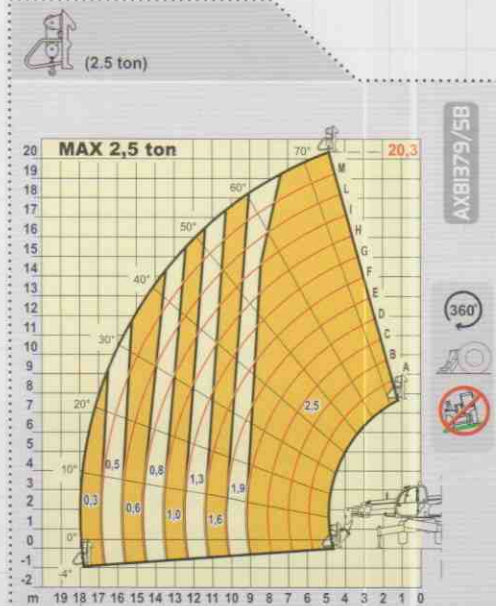
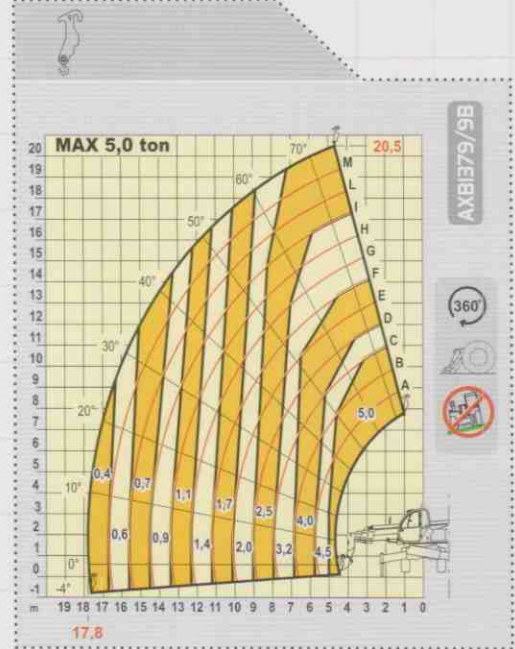
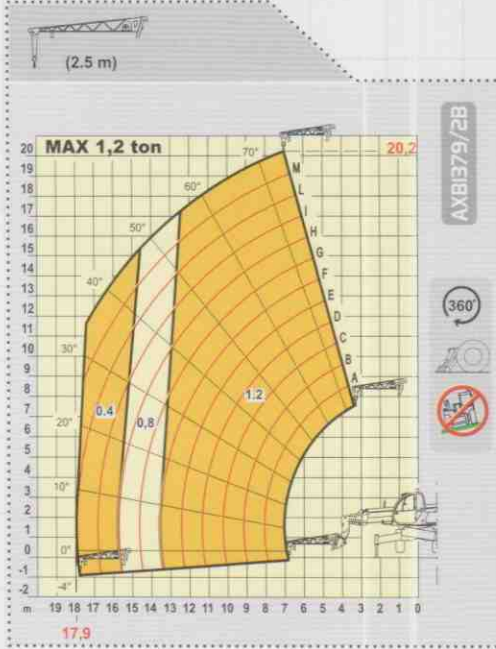
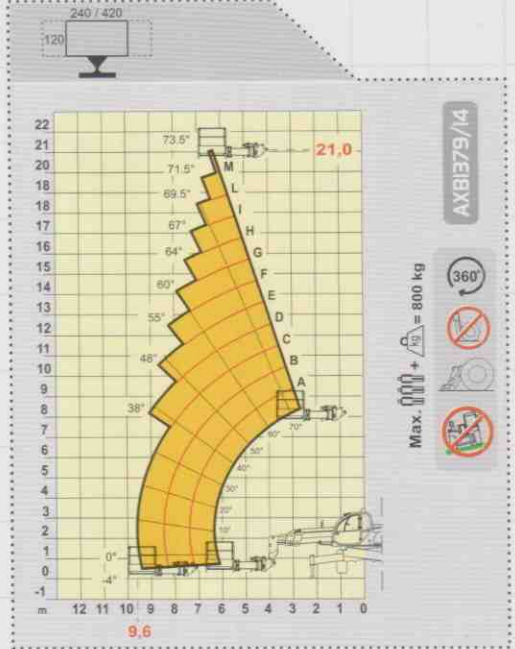
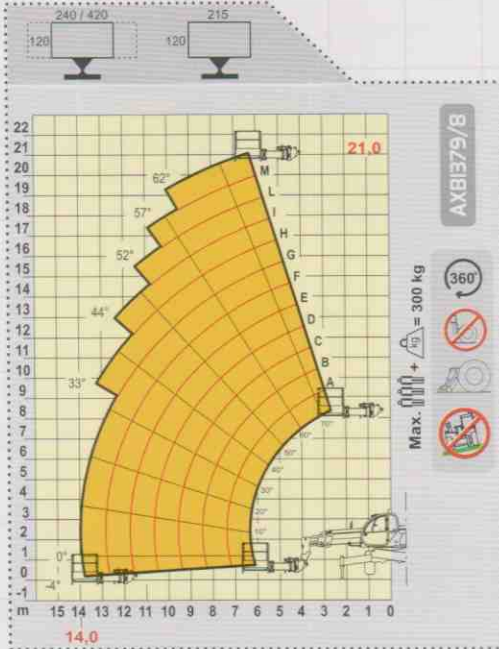
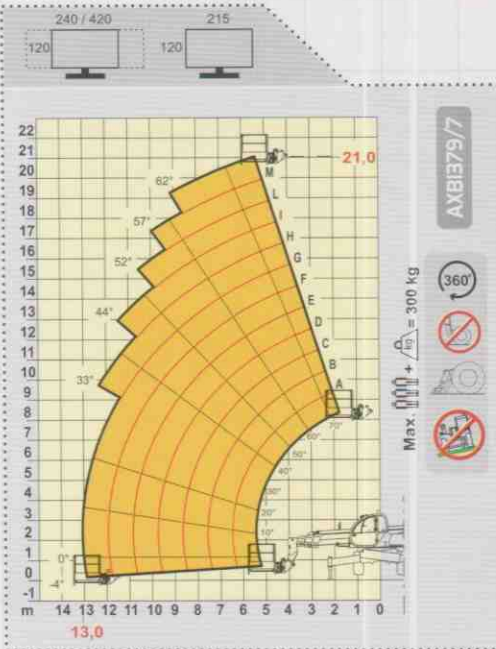

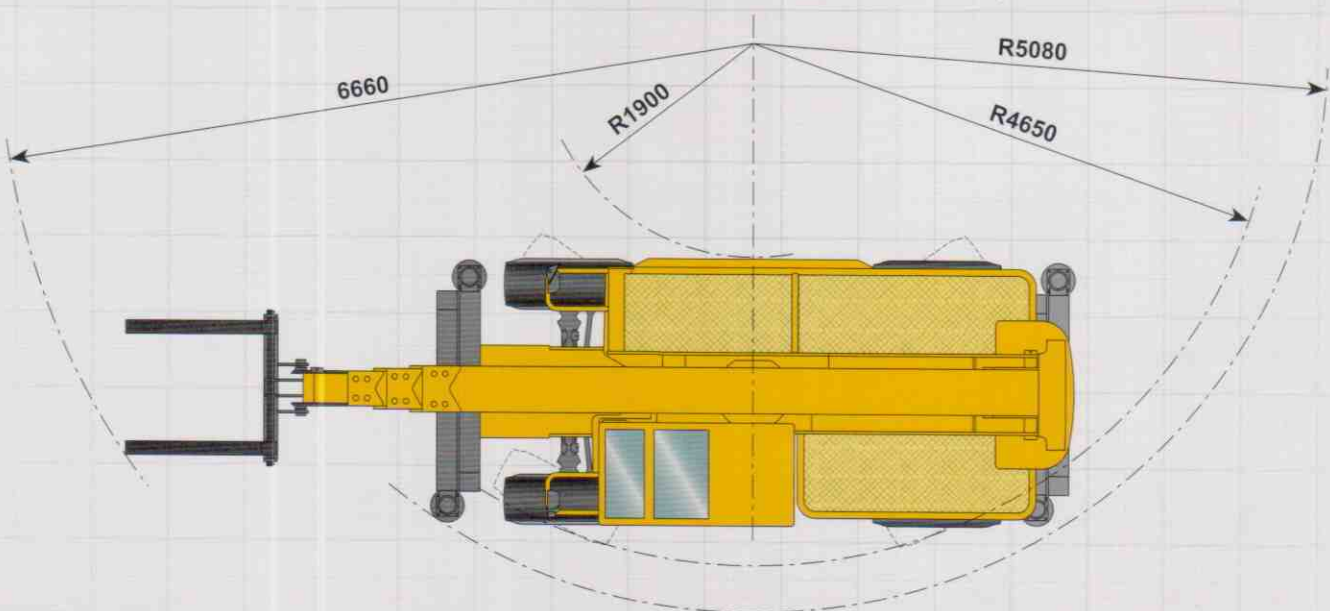
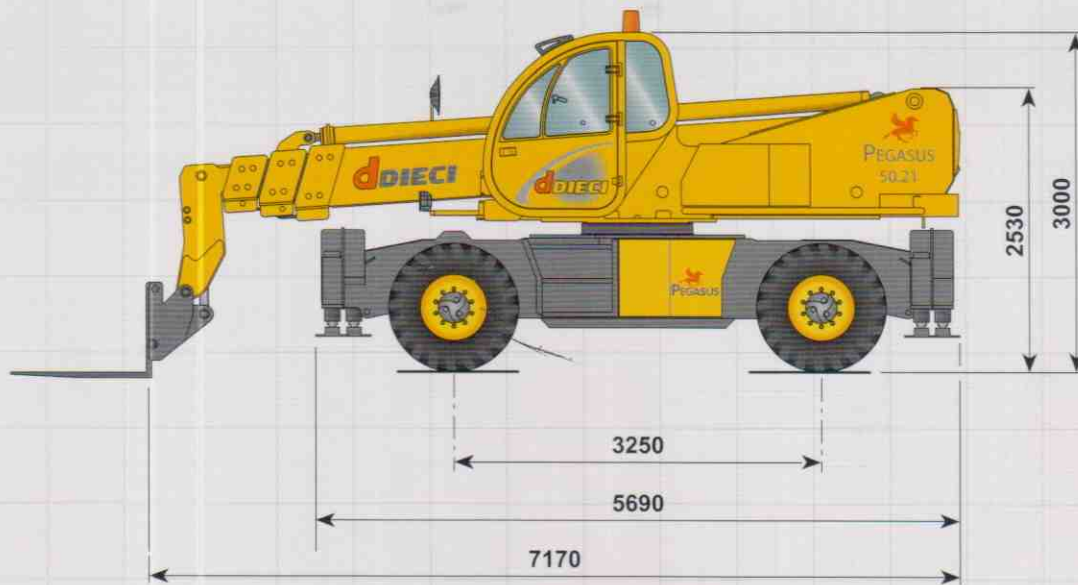

I dati contenuti in questo stampato sono forniti a titolo indicativo: i modelli descritti sono suscettibili di modifiche, senza preavviso, da parte del costruttore, disegni e fotografie possono riferirsi a equipaggiamenti opzionali o ad allestimenti destinati ad altri paesi. Per ogni altra informazione, rivolgersi alla sede DIECI all'indirizzo a fondo scheda.
 The information contained in the present publication is only intended as an indication: the models described may be modified, without notice, by the manufacturer, drawings and photographs may refer to optional equipment or to particular specifications for other countries. For any further information, please contact DIECI headquarters at the address given below.

(Cod. AXE3092 - 9/2006 v1)

DIECI S.r.l.
 Via E. Majorana, 2-4 - 42027 Montecchio Emilia (RE)
 Tel. +39 0522 869611 - Fax +39 0522 869744
 www.dieci.com - mailbox@dieci.com

