



**TEST REPORT  
EVALUATION OF STRUCTURAL WALL BRACING CAPACITY  
(MAXIMUM HEIGHT 2.7M) USING WILMAPLEX HOOP IRON  
WITH TENSIONER**

**CLIENT:**

**WILMAPLEX PTY LTD.  
57 LATHAMS ROAD,  
CARRUM DOWNS, VIC 3201**

**TESTING AUTHORITY:**

**MONASH UNIVERSITY  
DEPARTMENT OF CIVIL ENGINEERING  
WELLINGTON ROAD  
CLAYTON, VIC. 3800**

**JOB NUMBER: WILMAPLES/14/001**

**REPORT NUMBER: 14/012**

*Prepared By: Dr C ADAM*

**This Test Report refers to testing only one sample  
This Test Report can only be reproduced in full**

**14 NOVEMBER 2014**

## Table of Contents

Table of Contents .....	2
1. Introduction.....	3
2. Executive summary of test results .....	3
Table 1    Recommended design racking load for strength.....	3
3. Test specimens details.....	3
Figure 1    Wall frame specimen for 450mm stud spacing.....	4
Figure 2    Racking specimen for 600mm stud spacing .....	4
4. Testing methodology .....	5
Figure 3    Racking load test setup taken from ASTM E72 .....	6
5. Test results and analysis.....	6
Table 2    Summary of test data analysis and evaluation for walls with 450mm stud spacing.....	7
Table 3    Summary of test data analysis and evaluation for walls with 600mm stud spacing.....	7
6. Detailed test results .....	8
Figure 5    Racking load versus net deflection D3 for 450mm stud spacing...8	
Figure 6    Racking load versus net deflection D3 for 600mm stud.....9	
APPENDIX.....	10
Figure A1    Test set-up for the 450mm studs wall.....	11
Figure A2    Transducers measuring the uplift. ....	11
Figure A3    Hydraulic cylinder and a load cell fitted to apply the racking load. .....	12
Figure A4    Typical mode of failure, diagonal distortion and buckling of strap in the compression side.....	13
Figure A5    Steel test certificate.....	14

## 1. Introduction

Monash University was commissioned by Wilmaplex Pty. Ltd. to evaluate the structural bracing wall capacity (horizontal racking resistance) for of timber walls braced with 30x0.8mm Wilmaplex Hoop Iron straps, with studs spaced at 450 and 600mm centre to centre, as shown in Figures 1 and 2. The wall frames comprised of 90x45mm MGP10 Radiata pine frames with the straps nailed to the frame using 33mmx3.15mm flat head galvanized nails. Three replicates of each stud spacing specimens were tested at the structures laboratory at Monash University, Clayton Campus.

## 2. Executive summary of test results

**Table 1 Recommended design racking load for strength**

<b>One row of nogging, see Figures 1 and 2.</b>			
<b>Stress grade and size</b>	<b>Steel strap size (mm)</b>	<b>Stud spacing (mm)</b>	<b>Bracing capacity (kN/m)</b>
<b>MGP10 90x45mm</b>	<b>30x0.8mmG300 Z275 steel</b>	<b>450</b>	<b>1.5</b>
		<b>600</b>	<b>1.4</b>

## 3. Test specimens details

Six MGP10 wall frames fitted with Wilmaplex Hoop iron straps and tensioner were delivered at Monash University for testing. All wall frames comprised of 90x45mm MGP radiata pine components with the first three having a 450mm stud spacing, and the second three with a 450mm stud spacing, see Figures 1 and 2. All wall frames were braced using Wilmaplex 30x0.8mm G300 Z275 steel straps, the braces were tensioned using Wilmaplex galvanized steel tensioners. The straps were connected to the top and bottom plates with 2x33mmx3.15mm nails, one on the top face and the second on the side, straps were connected to the studs with one similar nail where the strap intersected with the studs. The straps cover the following Wilmaplex codes as given in the wilmaplex 2013 catalogue, 3086M, 30815M, 30830M and 30850M. The tensioner is identified as TEN in the same catalogue.

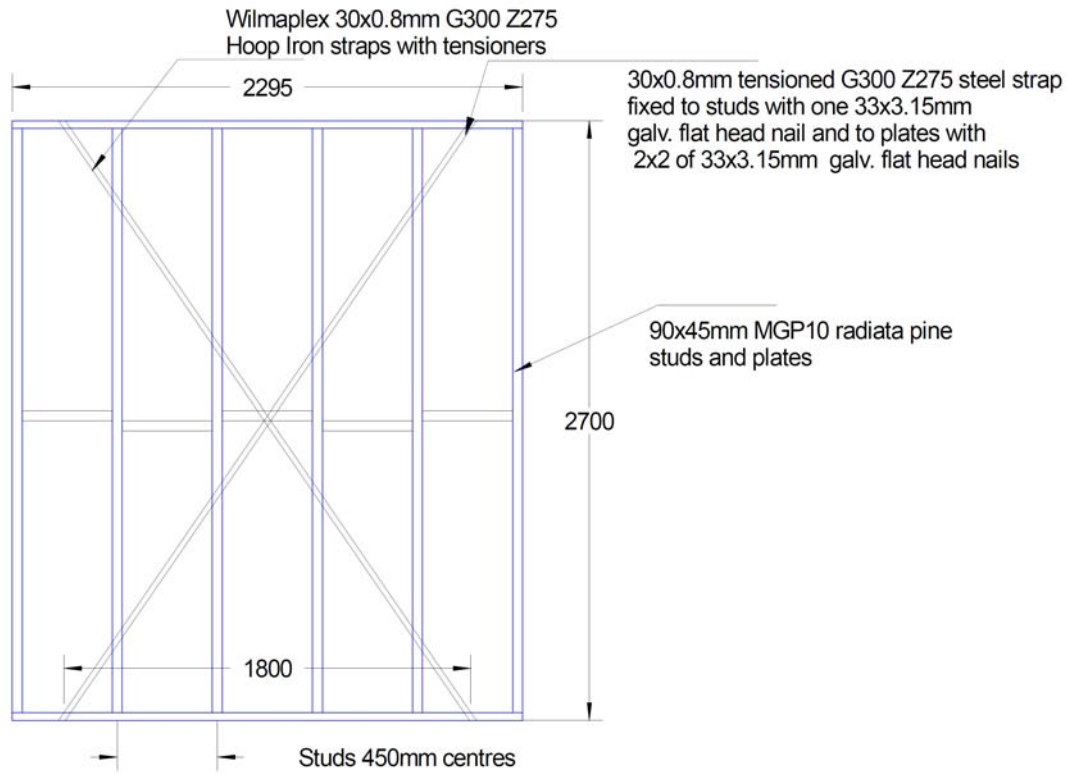

**Figure 1** Wall frame specimen for 450mm stud spacing

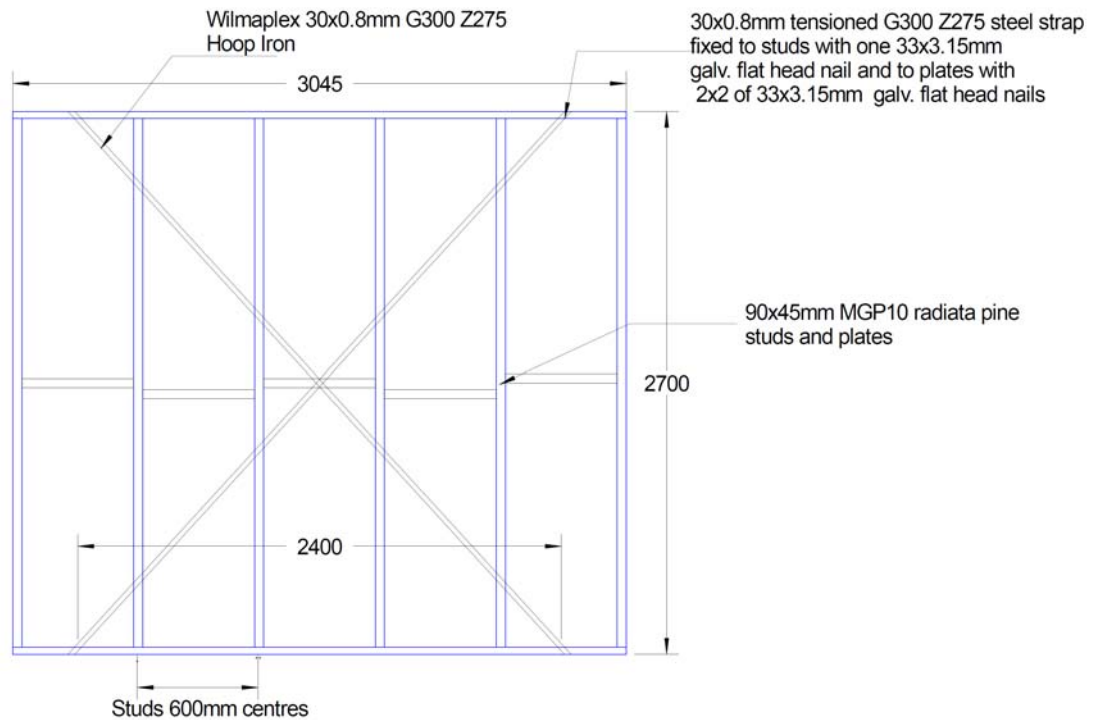

**Figure 2** Racking specimen for 600mm stud spacing

#### 4. Testing methodology

The test set-up used was similar to the method used in ASTM E72, Section 14. The test set up is shown in Figure 4, which was extracted from ASTM E72. The load was applied using a hydraulic cylinder fitted with a 50kN calibrated load cell. Four transducers were fitted onto the assembly; the first two ( $D_{1a\&b}$ ) were located on the lower left of the wall to measure the rotation; the rotation was measured averaging the two readings. The third transducer ( $D_2$ ) was located on the lower right end to measure the slippage and the fourth transducer ( $D_3$ ) located on the upper right end measured the total of the first three transducers plus the deformation of the panel. The net horizontal deflection of the panel at any given load, in accordance with ASTM E72, was the reading of  $D_3$  less the sum of the readings of the average of  $D_{1a\&b}$  and  $D_2$ . Test data from all transducers and load sensors were electronically recorded.

$$\text{Net deflection} = D_3 - (D_1 + D_2)$$

*Note that  $D_{1a\&b}$  represents the average of 2 transducers that were fitted to measure the rotation of the panel.*

The loading sequence followed during the racking test was to:

- apply a preload of 0.2 kN; no deflections recorded;
  - load continuously increased to a level of 2kN, in around 2minutes.
  - hold load for 5 minutes; then release the load
- note the residual deflections;
- allow 5 minutes recovery time;
  - reload to 2kN level record deflections;
  - continue loading to failure and note the racking load at a deflection of 9 and 27mm, i.e. height/300 and height/100; the height was 2.7m.

After each loading cycle wall assemblies were closely examined for any signs of material or connector distress or buckling especially at the serviceability limit state levels.

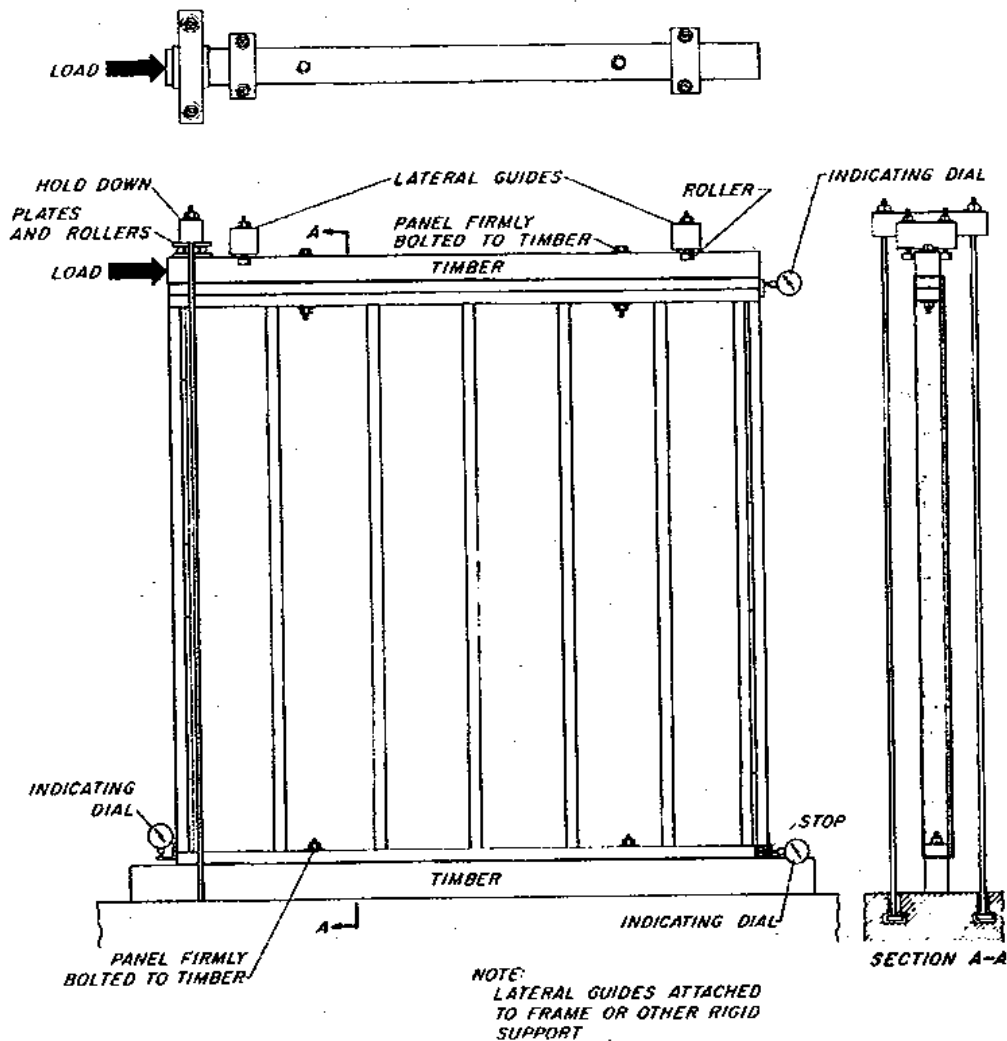
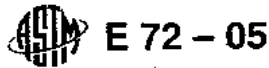

Figure 3 Racking load test setup taken from ASTM E72

## 5. Test results and analysis

The following criteria was followed in order to satisfy the limit state design criteria. Limit state design criteria requires that a serviceability limit (SLS) is met, this was undertaken via imposing a deflection limit of height/300, which is 9mm for the specimens tested, at this deflection level the specimen did not to show any significant signs of buckling or failure and shall be stable.

A strength limit state was established by determining the racking load capacity (ULS) at a deflection of height/100, which is 27mm for the specimens tested, at this load level the specimen continues to resist further load despite some material and fasteners might look under stress.

The recommended racking load capacity was considered to be the most critical value of the minimums of the following:

- The strength limit design load (ULS) shall be greater or equal to the serviceability limit state (SLS) load multiplied by a factor 1.5 to ensure stability.

- The strength limit design load shall be less or equal to 0.85 of the ultimate load (ULT), this serves as what is defined as a capacity factor for limit state design in AS1720.1 for housing structures.

Tables 2 and 3 give all the calculated test data for the 450 and 600mm stud spacing consecutively.

**Table 2 Summary of test data analysis and evaluation for walls with 450mm stud spacing**

Wall type	1.5xSLS	ULS	0.85xULT
1	0.9	1.6	1.6
2	1.2	1.6	1.6
3	1.2	1.6	1.6
<b>Mean</b>	<b>1.1</b>	<b>1.6</b>	<b>1.6</b>
<b>Minimum</b>		<b>1.6</b>	<b>1.6</b>

Note that in Table 1, the recommended bracing capacity is 1.5kN which is less than the tested value of 1.6kN to be compatible with AS1684.2, Table 8.18.

**Table 3 Summary of test data analysis and evaluation for walls with 600mm stud spacing**

Wall type	1.5xSLS	ULS	0.8xULT
1	0.9	1.5	1.5
2	0.6	1.4	1.4
3	0.6	1.5	1.4
<b>Mean</b>	<b>0.7</b>	<b>1.5</b>	<b>1.4</b>
<b>Minimum</b>		<b>1.4</b>	<b>1.4</b>

Note that the recommended bracing capacity is 1.4kN which is less than the 1.5kN quoted in AS1684.2, Table 8.18, the difference between the layout described in Table 8.18 and the actual wall panel tested is that the tested wall bracing strap was connected to the plates with 2 nails only in lieu of the AS1684's 3 nails.

## 6. Detailed test results

### 6.1. Walls with 450mm stud spacing test results

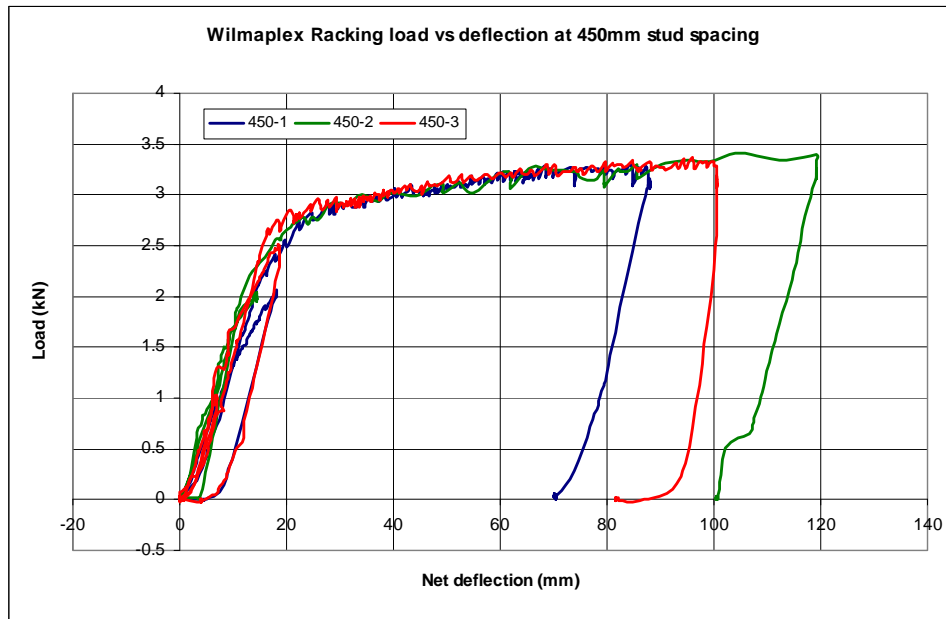

**Figure 5** Racking load versus net deflection D3 for 450mm stud spacing

**Mode of failure:**

**Specimen 450-1, 2 and 3:** Frame distorting diagonally, strap buckling on the compression side.



## 6.2. Walls with 600mm stud spacing test results

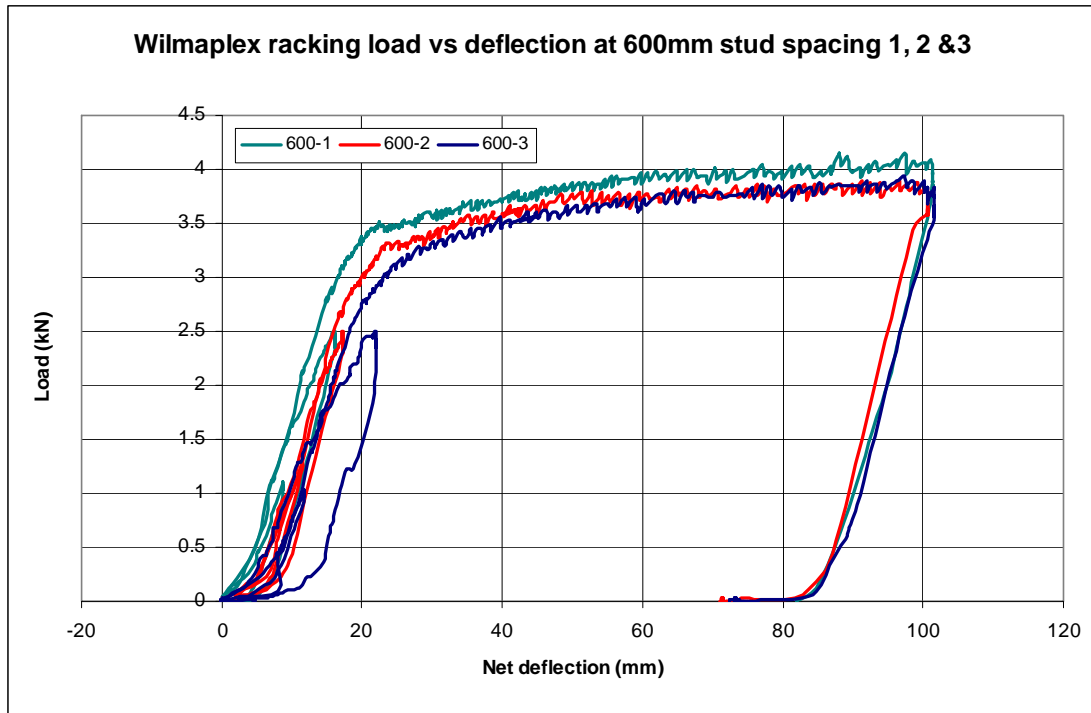

**Figure 6** Racking load versus net deflection D3 for 600mm stud

**Mode of failure:**

**Specimen 600-1, 2 and 3:** Frame distorting diagonally, strap buckling on the compression side.

## **APPENDIX**



**Figure A1** Test set-up for the 450mm studs wall



**Figure A2** Transducers measuring the uplift.



*Figure A3 Hydraulic cylinder and a load cell fitted to apply the racking load.*





***Figure A4 Typical mode of failure, diagonal distortion and buckling of strap in the compression side.***



**TEST CERTIFICATE**

Customer: SELECTION STEEL SALES PTY. LTD 64-66 VENTURA PLACE DANDENONG SOUTH VIC 3175	Supplier: Bluescope Steel Limited WESTERN PORT, VIC, AUSTRALIA A.B.N. 16 000 011 058
Cust Order No: 201244	MOI No: 955399 Printed At: Supplier MWS on: 12/11/2014

Accredited for compliance with ISO/IEC 17025.

 Accredited for compliance with ISO/IEC 17025.

I certify that the original records of the company show that the item(s) referred to on this certificate conform to the specification as stated and that the product test results on this certificate supercede product test results on any other certificate.

K. ANNETT - BLUESCOPE STEEL APPROVED SIGNATORY  
 Chemical LAB 0632

PRODUCT: GALV G300 Z275

**CHEMICAL ANALYSIS**

(Chemical Analysis supplied by the Steelmaker. Basic Oxygen Steelmaking process.)

SPECIFICATION: NO SPEC.

Item No	Dimensions (mm)	PACK No	NATA Lab	CHEMICAL COMPOSITION PERCENT														
				HEAT No	C	P	Mn	Si	S	Ni	Cr	Mo	Cu	Al	Ti	Nb	V	Sn
01	0.70 x 915	N39739	0632	6388819	.093	.022	.42	<.005	.019	.017	.026	.005	.040	.026	<.002	.001	<.003	.002
01	0.70 x 915	N39740	0632	6388819	.093	.022	.42	<.005	.019	.017	.026	.005	.040	.026	<.002	.001	<.003	.002
01	0.70 x 915	N39741	0632	6388819	.093	.022	.42	<.005	.019	.017	.026	.005	.040	.026	<.002	.001	<.003	.002
01	0.70 x 915	N39743	0632	6388819	.093	.022	.42	<.005	.019	.017	.026	.005	.040	.026	<.002	.001	<.003	.002
01	0.70 x 915	N39734	0632	6388829	.083	.020	.42	<.005	.018	.017	.026	.005	.042	.034	<.002	.001	<.003	.005
01	0.70 x 915	N39736	0632	6388829	.083	.020	.42	<.005	.018	.017	.026	.005	.042	.034	<.002	.001	<.003	.005

Item No	Dimensions (mm)	PACK No	NATA Lab	CHEMICAL COMPOSITION PERCENT		
				HEAT No	N	
01	0.70 x 915	N39739	0632	6388819	.0037	
01	0.70 x 915	N39740	0632	6388819	.0037	
01	0.70 x 915	N39741	0632	6388819	.0037	
01	0.70 x 915	N39743	0632	6388819	.0037	
01	0.70 x 915	N39734	0632	6388829	.0035	
01	0.70 x 915	N39736	0632	6388829	.0035	

Figure A5 Steel test certificate